

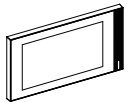

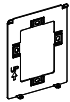



Unpacking

Before using the device, check the device model and ensure that the shipped box includes the following items:

 1 X S562	 1 X Wall-mounting bracket	 2 X ST4x20 crosshead screw	 2 X M2x5 crosshead screw
 1 X Crosshead screwdriver	 1 X 8-Pin cable	 1 X 10-Pin cable	 1 X Diode
 2 X M4x20 crosshead screw	 2 X #6-30 Phillips machine screw	 2 X ST3x20 crosshead screw	 2 X Plastic wall anchors

Product Overview

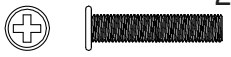
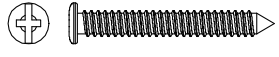
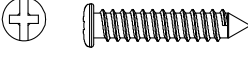
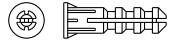

S562

Before You Start

Tools needed

(not included in shipped box)

- Cat Ethernet Cable
- Crosshead Screwdriver

Voltage and Current Specifications

- It is suggested that use PoE or 12VDC 1A power adapter to power on device.

AWG Sizes and Properties Table

Please follow the properly wire data to install device:

Power Supply	12VDC 1A				
AWG	16	18	20	22	24
Resistance (ohm/km)	13.5	21.4	33.9	48.5	79.6
Cross-sectional Area (mm ²)	1.318	0.8107	0.5189	0.3247	0.2047
Wire Length (m)	≤ 50	≤ 50	≤ 50	≤ 40	≤ 20

Requirements

1. Place the device away from sunlight and light sources to prevent potential damage.
2. Do not place the device in the high-temperature, and humid environments or in surroundings impacted by magnetic field.
3. Install the device on the flat surface securely to avoid personal injuries and property loss caused by device's falling.
4. Do not use or place the device near heating objects.
5. Please keep device at least 2 meters away from light, and at least 3 meters away from window and door.

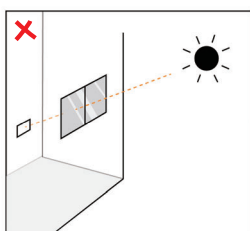

Direct sun through window

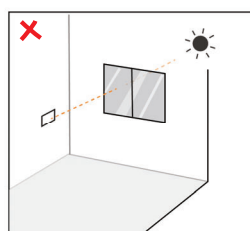

Indirect sunlight through window

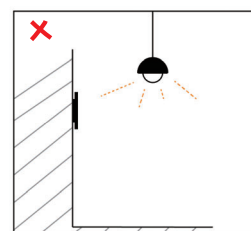

Close to light

Warning!

1. To ensure safety, avoid touching power cord, power adapter, and device with wet hands, bending or pulling the power cord, damaging any components, and use only qualified power adapter and power cord.
2. Be careful that standing up on the area under the device in case of personal injuries cause by hitting the device.

Caution

1. Do not knock device with hard objects.
2. Do not press down hard on the device screen.
3. Do not expose device to chemical products, such as alcohol, acid liquid, disinfectants, and so on.
4. To prevent the device installation from becoming loose, ensure accurate diameters and depths of screw holes. If the screw holes are too large, use glue to secure the screws.
5. Use wet cloth clean device surface softly, and then wipe the surface with dry cloth for cleaning the device.
6. If there is abnormal situation of the device, including uncommon sound and smell, please power off the device and contact Akuvox Technical Team immediately.

Wiring Interface

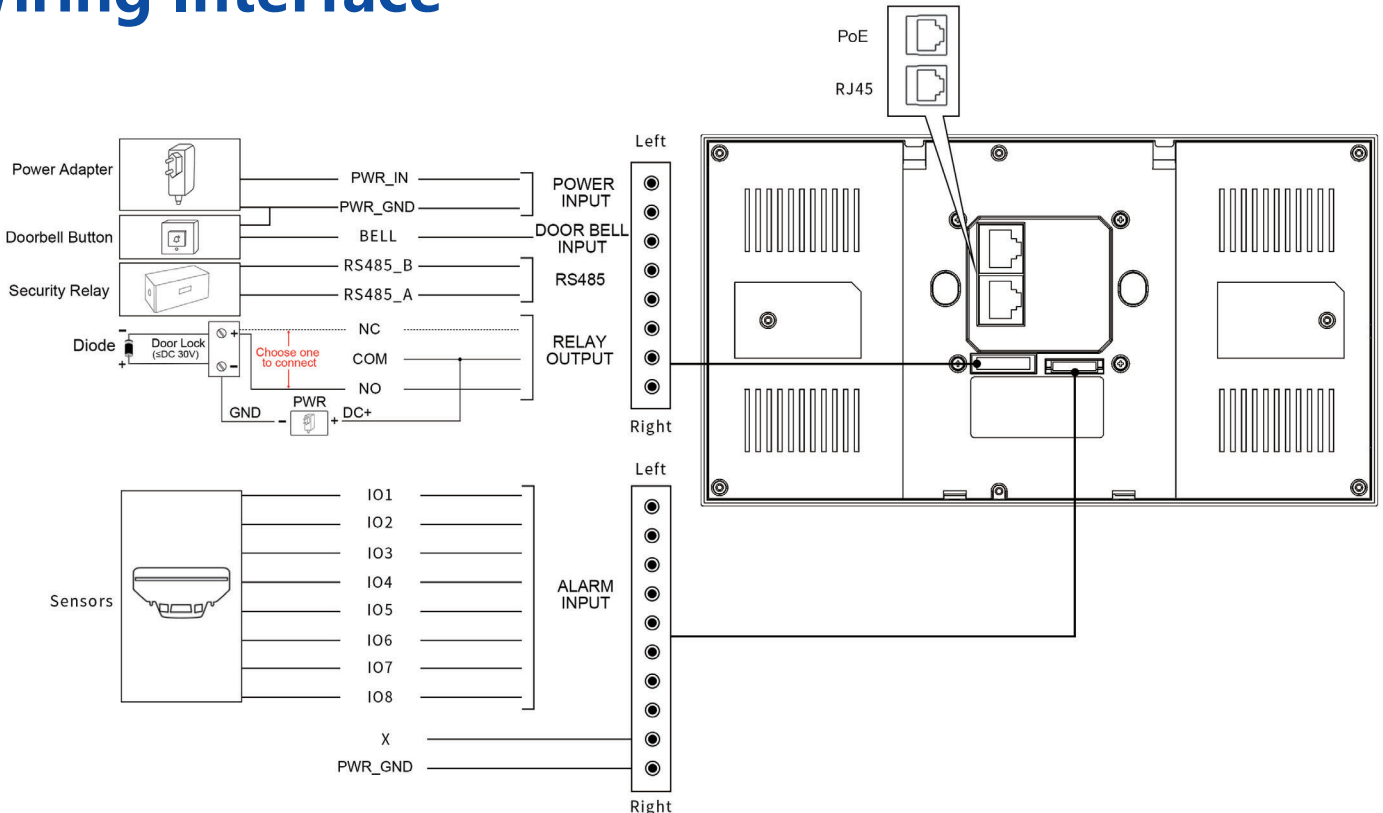

To protect the device from potential damage caused by over-voltage, it is recommended to wire a diode into the circuit. Connect the anode of the diode to the negative cable of the lock, and connect the cathode of the diode to the positive cable of the lock.

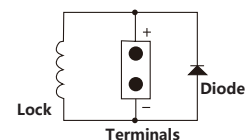

Installation

Step 1: Bracket Installation

With 86 junction box in the wall

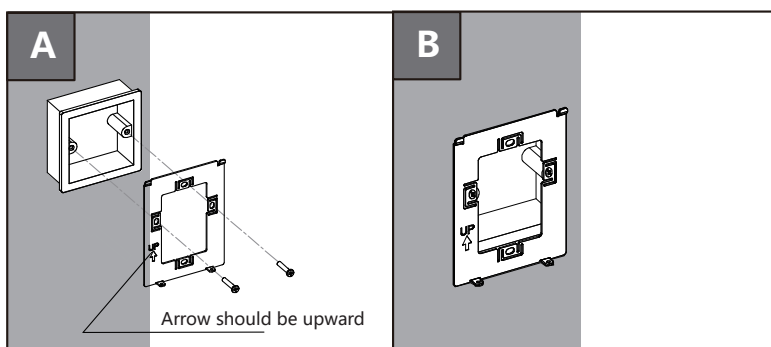

Fix the **wall-mounting bracket** on the 86 junction box with two **M4x20 crosshead screws**, please ensure the bracket against to wall.

With 118 junction box in the wall

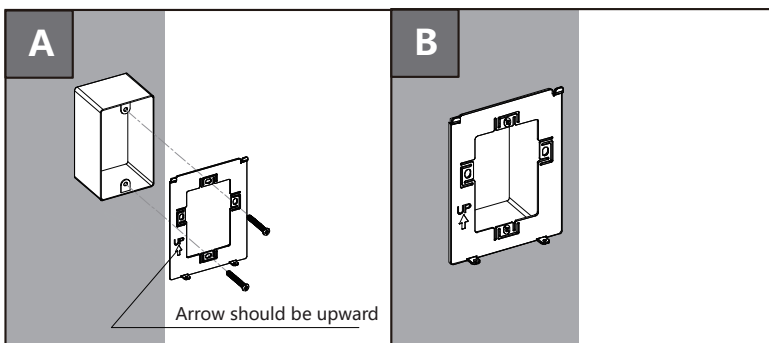

Fix the **wall-mounting bracket** on the 118 junction box with two **#6-30 Philips machine screws**, please ensure the bracket against to wall.

With round junction box in the wall

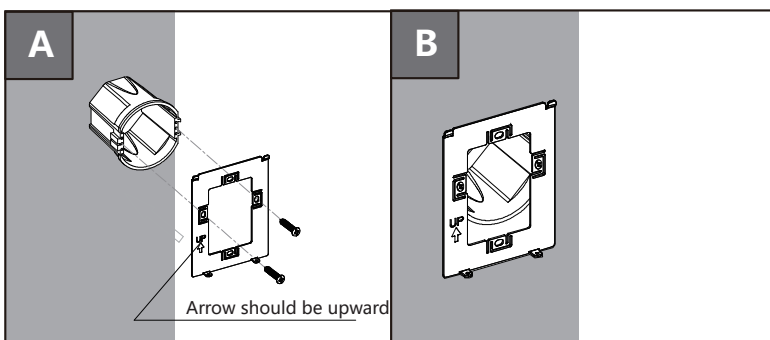

Fix the **wall-mounting bracket** on the round junction box with two **ST3x20 crosshead screws**, please ensure the bracket against to wall.

Without electrical junction box in the wall

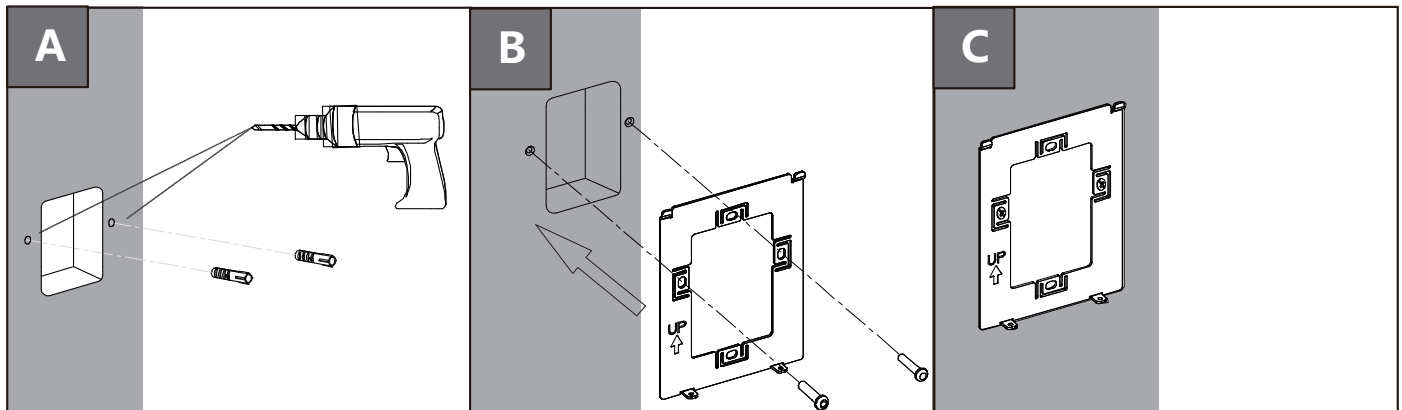

- According to the position of wires, use a 6mm electric drill to make two 20mm-depth holes horizontally.
- Then insert two **plastic wall anchors** into the holes. Please make sure that the top of plastic wall anchors can not be higher than wall.
- Fix the wall-mounting bracket on the wall with two **ST4X20 crosshead screws**, please ensure the bracket against to wall.

Step 2: Device Mounting

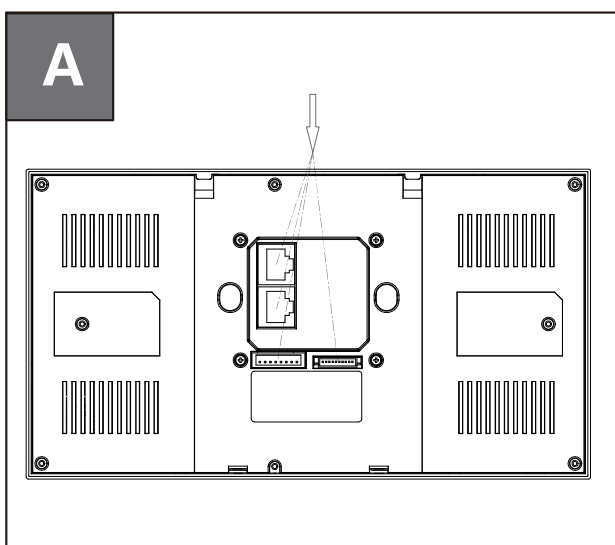

Plug the cables from the wall into corresponding interface on the back cover. (For details, refer to "Wiring Interface")

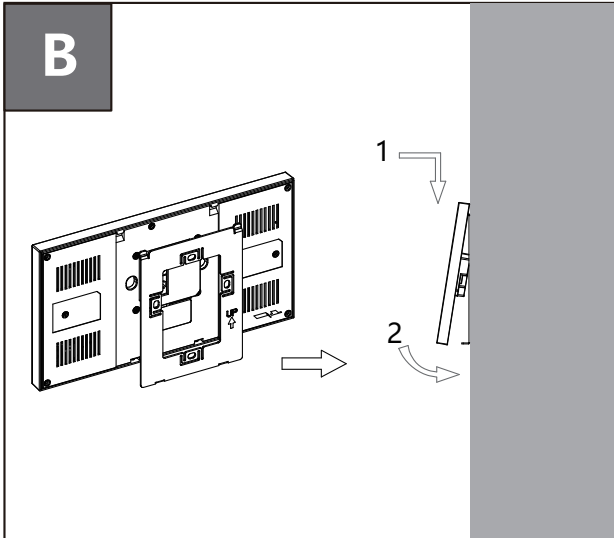

- As picture shown, tilt the device 15° and line up the holes on the back cover with the hooks on the bracket.
- Press the device into the brackets and slide down. Then push the device until it against the wall.

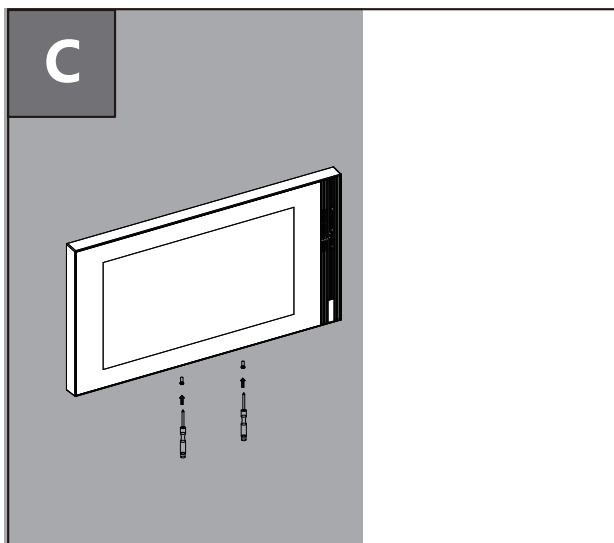

Use **Crosshead screwdriver** to secure two **M2x5 crosshead screw** into the bottom of the device. Check the device if is stable, and the installation is done.

Device Removal

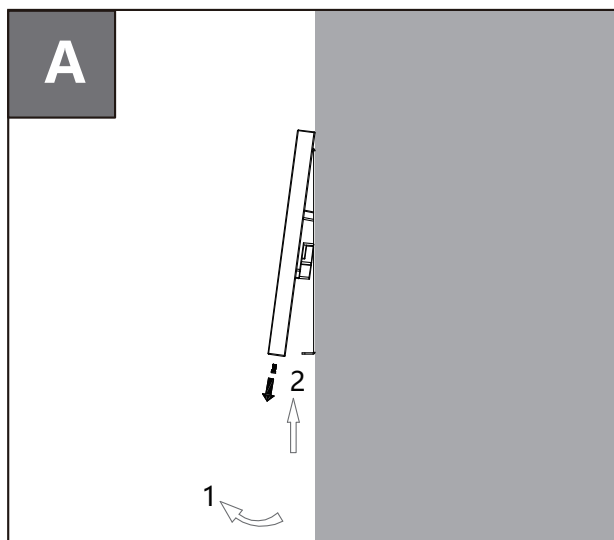

- Use **Crosshead screwdriver** to remove the two **M2x5 crosshead screw** on the bottom of the device
- Tilt the device 15° as shown in the picture and push up it to remove the device.



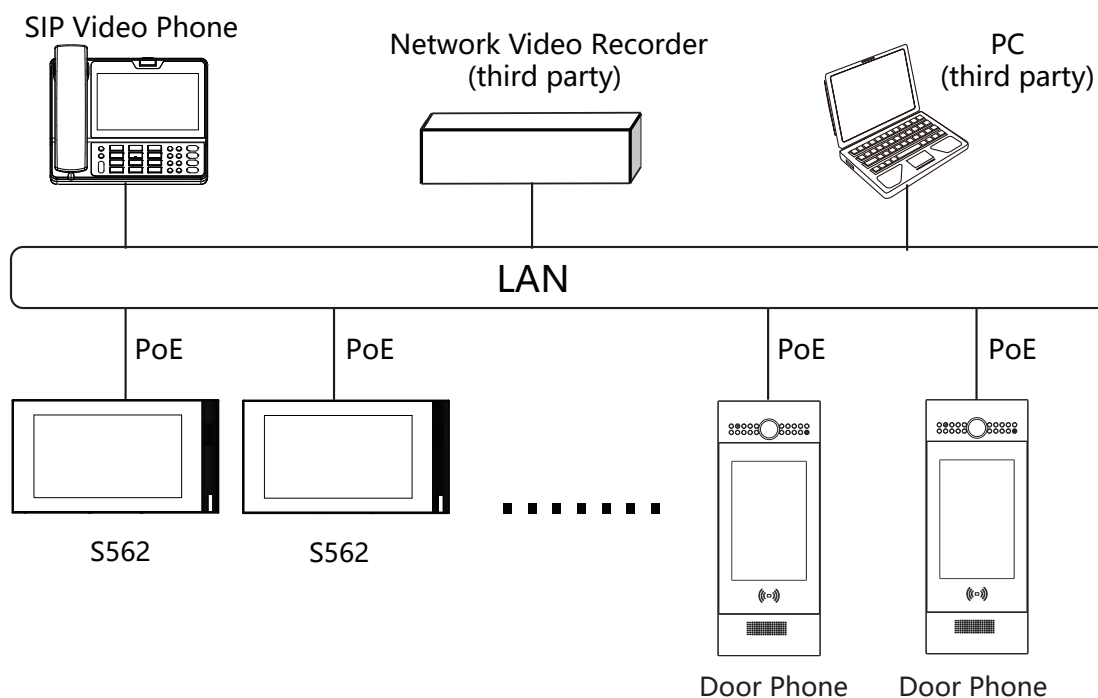

Application Network Topology



Device Test

Please verify the device status after installation:

1. **Network:** Navigate to **Setting > System Info** to check the device's IP address and network status. Network is working properly if the IP address is obtained.

2. **Intercom:** Dial the callee's or APT number, and press **Dial**  **icon** to make an audio call or press **Video**  **icon** to make a video call. The call configuration is correct if the call is successful.

3. **Access Control:** Press **Unlock**  **icon** on the monitor interface to unlock the door.

Warranty

1. Akuvox warranty does not cover intentional mechanical damage or destruction caused by improper installation.
2. Do not attempt to modify, alternate, maintain, or repair device by yourself. Akuvox warranty does not apply to damages caused by anyone who is not representative of Akuvox or an Akuvox authorized service provider. Please contact Akuvox Technical Team if the device needs to be repaired.

Get Help

For help or more assistance, contact us at:

 <https://ticket.akuvox.com/>

 support@akuvox.com

Scan the QR code to get more videos, guides, and additional product information.



Notice Information

Akuvox S562 firmware contains third-party open source software under the terms of the GNU General Public License (GPL). Akuvox is committed to meeting the requirements of the GNU General Public License (GPL) and will make all required source code available.

The source code of software under the terms of GNU GPL can be downloaded online, <http://www.akuvox.com/gpl>.

Information contained in this document is believed to be accurate and reliable at the time of printing. This document is subject to change without notice, any update to this document can be viewed on Akuvox' s website: <http://www.akuvox.com> © Copyright 2023 Akuvox Ltd. All rights reserved.